

# MILLER TABLE

## DESIGN SPECIFICATIONS

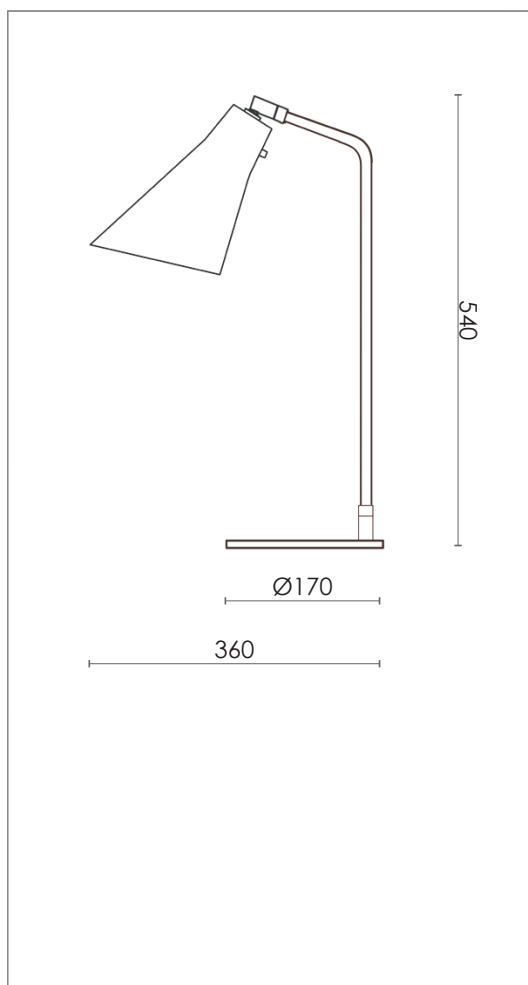







<b>DIMENSIONS (mm)</b>	H 540 x D 360 - BASE Ø 170
<b>WEIGHT (kg)</b>	2,3
<b>MATERIALS</b>	THE LAMP IS MADE FROM CLEAR LACQURED BRASS OR POWDER COATED STEEL
<b>CORD (mm)</b>	BLACK TEXTILE - L 2300
<b>ENVIRONMENT</b>	INDOOR
<b>DESIGN BY</b>	NICLAS HOFLIN
<b>DESIGN YEAR</b>	2014



## ELECTRICAL SPECIFICATIONS

<b>SWITCH</b>	ON / OFF
<b>BULB HOLDER</b>	GU10
<b>LIGHT SOURCE</b>	INCLUDED DIMMABLE 4 W LED - 2700 K
<b>DIMMABLE</b>	YES
<b>MAX (W)</b>	6 W LED
<b>VOLTAGE</b>	230 / 240
<b>CLASS</b>	2
<b>IP</b>	20

## COLOURS

 <b>BLACK</b>	ART.NO. 850174005	 <b>UMBRA GREY / BRASS</b>	ART.NO. 850171126
 <b>BLACK / BRASS</b>	ART.NO. 850171005	 <b>LIGHT SAND / BRASS</b>	ART.NO. 850171127
 <b>SILK GREY / BRASS</b>	ART.NO. 850171110	 <b>SLATE GREY / STEEL</b>	ART.NO. 850173025
 <b>SLATE GREY / BRASS</b>	ART.NO. 850171125	 <b>UMBRA GREY / STEEL</b>	ART.NO. 850173026