

2017 SPRING/SUMMER



VALID FROM APRIL 1ST

# **MADE BY HAND**

**DATASHEET**

**WORKSHOP LAMP**

# THE WORKSHOP LAMP



IN THE  
WORKSHOP



## MATERIALS



Powdercoated



Laquered Aluminium



Copper & White



Weathered Copper

## COLOURS



Shiny Black



Matte Black



Dark Black



Anthracite Black



Anthracite Grey



Grey



Matte White



White



Yellow



Light Rosa



Mint



Petroleum Blue



Blue

WORKSHOP LAMP SERIES

W5

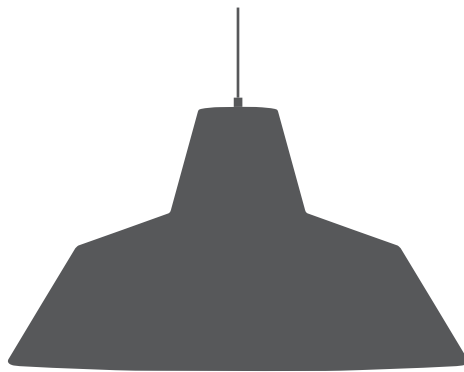

W3

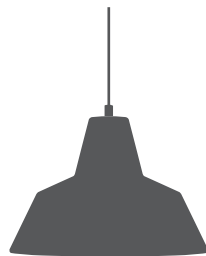

W4

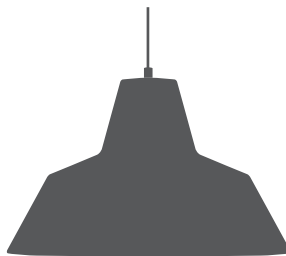

W2

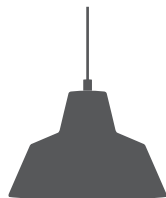

W1



## WORKSHOP LAMP / W1



Made By Hand in Copenhagen manufactures the Workshop lamp collection by A. Wedel-Madsen. Made of aluminium, the workshop lamp is not too heavy but still the thickness of the lamp shade, solid socket and wire cloth are all part of the crafted quality and the selection of durable materials that create the workshop lamp.

**Design:** A. Wedel-Madsen

**Year:** 1951

**Material:** Aluminium

Made in Denmark

## Shade colours



Shiny black



Matte black



Dark black



Anthracite black



Anthracite grey



Grey



Matte white



White



Yellow



Light Rosa



Mint



Petroleum blue



Blue

## Measurements

Shade height: 125 mm

Shade diameter: 180 mm

Cord length: 3000 mm

## Certifications

CE-Certified

IP20

## Recommended Lightsource

Socket: E14

Max wattage: 40 W

## Packaging Measurements

L: 217 x W: 217 x H: 200 mm

## Weight (lamp + packaging = total)

Total: 0,55 kg

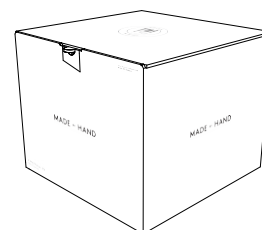
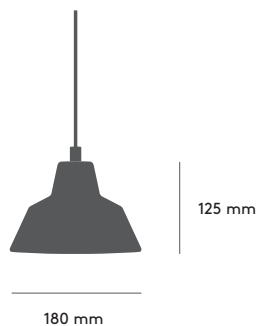

## WORKSHOP LAMP / W2



Made By Hand in Copenhagen manufactures the Workshop lamp collection by A. Wedel-Madsen. Made of aluminium, the workshop lamp is not too heavy but still the thickness of the lamp shade, solid socket and wire cloth are all part of the crafted quality and the selection of durable materials that create the workshop lamp.

**Design:** A. Wedel-Madsen

**Year:** 1951

**Material:** Aluminium

Made in Denmark

## Shade colours



## Measurements

Shade height: 190 mm

Shade diameter: 280 mm

Cord length: 3000 mm

## Certifications

CE-Certified

IP20

## Recommended Lightsource

Socket: E27

Max wattage: 60 W

## Packaging Measurements

L: 297 x W: 297 x H: 240 mm

## Weight (lamp + packaging = total)

Total: 1,24 kg

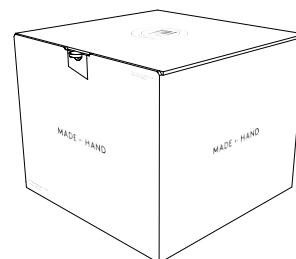
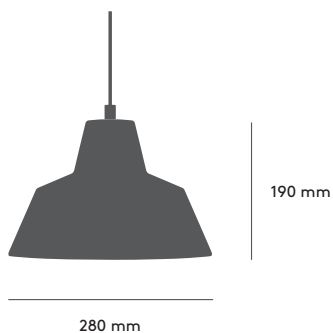



## WORKSHOP LAMP / W3



Made By Hand in Copenhagen manufactures the Workshop lamp collection by A. Wedel-Madsen. Made of aluminium, the workshop lamp is not too heavy but still the thickness of the lamp shade, solid socket and wire cloth are all part of the crafted quality and the selection of durable materials that create the workshop lamp.

**Design:** A. Wedel-Madsen

**Year:** 1951

**Material:** Aluminium

Made in Denmark

## Shade colours



## Measurements

Shade height: 240 mm

Shade diameter: 350 mm

Cord length: 3000 mm

## Certifications

CE-Certified

IP20

## Recommended Lightsource

Socket: E27

Max wattage: 60 W

## Packaging Measurements

L: 362 x W: 362 x H: 290 mm

## Weight (lamp + packaging = total)

Total: 1,9 kg

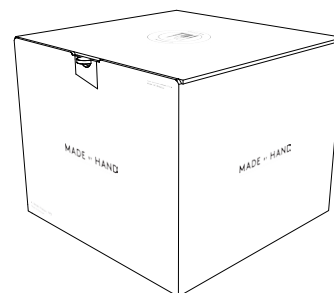
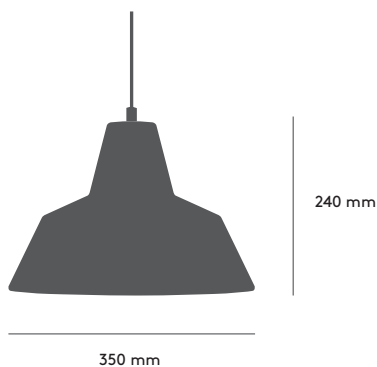

**WORKSHOP LAMP / W4**



Made By Hand in Copenhagen manufactures the Workshop lamp collection by A. Wedel-Madsen. Made of aluminium, the workshop lamp is not too heavy but still the thickness of the lamp shade, solid socket and wire cloth are all part of the crafted quality and the selection of durable materials that create the workshop lamp.

**Design:** A. Wedel-Madsen

**Year:** 1951

**Material:** Aluminium

Made in Denmark

**Shade colours**



**Measurements**

Shade height: 305 mm

Shade diameter: 500 mm

Cord length: 3000 mm

**Certifications**

CE-Certified

IP20

**Recommended Lightsource**

Socket: E27

Max wattage: 60 W

**Packaging Measurements**

L: 510 x W: 510 x H: 365 mm

**Weight (lamp + packaging = total)**

Total: 3,24 kg

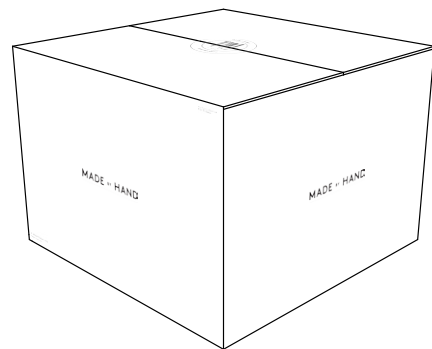
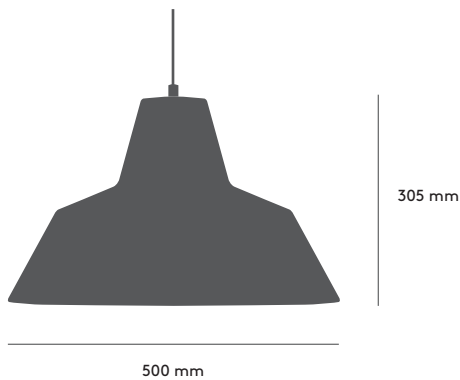

**WORKSHOP LAMP / W5**



Made By Hand in Copenhagen manufactures the Workshop lamp collection by A. Wedel-Madsen. Made of aluminium, the workshop lamp is not too heavy but still the thickness of the lamp shade, solid socket and wire cloth are all part of the crafted quality and the selection of durable materials that create the workshop lamp.

**Design:** A. Wedel-Madsen

**Year:** 1951

**Material:** Aluminium

Made in Denmark

**Shade colours**

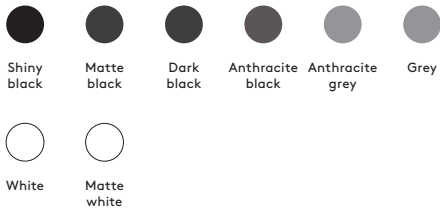

**Measurements**

Shade height: 455 mm

Shade diameter: 820 mm

Cord length: 3000 mm

**Certifications**

CE-Certified

IP20

**Recommended Lightsource**

Socket: E27

Max wattage: 60 W

**Packaging Measurements**

L: 845 x W: 845 x H: 490 mm

**Weight (lamp + packaging = total)**

Total: 8,06 kg

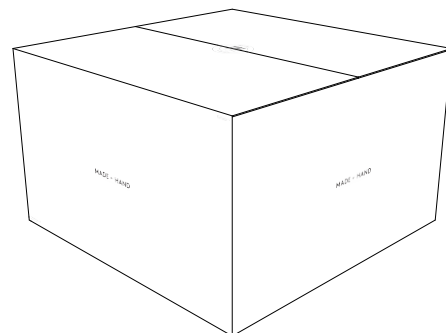
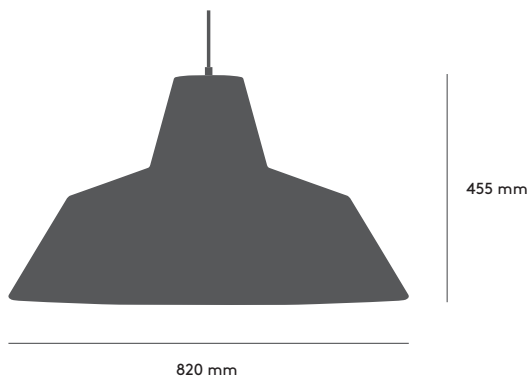

## LACQUERED ALUMINIUM

WORKSHOP LAMP W1 - W5



Made By Hand in Copenhagen manufacturer the Workshop lamp-collection by A. Wedel-Madsen. Made of aluminium, the workshop lamp is not too heavy but still the thickness of the lamp shade, solid socket and wire cloth are all part of the crafted quality and the selection of durable materials that create the workshop lamp.

**Design:** A. Wedel-Madsen

**Year:** 1951

**Material:** Aluminium

Made in Denmark

### Packaging

Packaging measurements

W1 L: 217x W: 217 x H: 200mm

W2 L: 297x W: 297 x H: 240mm

W3 L: 362 x W: 362 x H: 290 mm

W4 L: 510 x W: 510 x H: 365mm

W5 L: 845 x W: 845 x H: 490mm

Weight (Lamp + package = total):

W1 Total: 0,55 kg

W2 Total: 1,24 kg

W3 Total: 1,9 kg

W4 Total: 3,24 kg

W5 Total: 8,06 kg

### Measurements

#### W1

Shade height: 125 mm

Shade diameter: 180 mm

Cord length: 3000 mm

#### W2

Shade height: 190 mm

Shade diameter: 280 mm

Cord length: 3000 mm

#### W3

Shade height: 240 mm

Shade diameter: 350 mm

Cord length: 3000 mm

#### W4

Shadeheight: 305mm

Shade diameter: 500 mm

Cordlength: 3000mm

#### W5

Shadeheight: 455mm

Shade diameter: 820 mm

Cordlength: 3000mm

## COPPER & WHITE

### WORKSHOP LAMP W1 - W4



The workshop lamps in copper are made by hand in 3 different workshops in Denmark. Every single copper lamp is made in 100% pure copper, and is shaped by craftsmen using different tools. Each lamp has different finishes. Some lamps are lacquered with the purpose to maintain the look of the copper.

**Design:** A. Wedel-Madsen

**Year:** 1951

**Material:** Copper and white powdercoat

Made in Denmark

#### Packaging

##### Packaging measurements

W1 L: 217 x W: 217 x H: 200 mm

W2 L: 297 x W: 297 x H: 240 mm

W3 L: 362 x W: 362 x H: 290 mm

W4 L: 510 x W: 510 x H: 365 mm

##### Weight packaging (Lamp + package = total)

W1 Total: 0,74 kg

W2 Total: 1,78 kg

W3 Total: 2,65 kg

W4 Total: 3,92 kg

#### Measurements

##### W1

Shade height: 125 mm

Shade diameter: 180 mm

Cord length: 3000 mm

##### W2

Shade height: 190 mm

Shade diameter: 280 mm

Cord length: 3000 mm

##### W3

Shade height: 240 mm

Shade diameter: 350 mm

Cord length: 3000 mm

##### W4

Shadeheight: 305mm

Shade diameter: 500 mm

Cordlength: 3000mm

## WEATHERED COPPER

WORKSHOP LAMP W1 - W4



The workshop lamps in copper are made by hand in 3 different workshops in Denmark. Every single copper lamp is made in 100% pure copper, and is shaped by craftsmen using different tools. Each lamp has different finishes. Some lamps are lacquered with the purpose to maintain the look of the copper. The weathered copper lamp is put through an old-method of oxidation turning the raw copper into a beautiful dark-brown colour. Over time this lamp will patinate even more.

**Design:** A. Wedel-Madsen

**Year:** 1951

**Material:** Copper

Made in Denmark

### Packaging

#### Packaging measurements

W1 L: 217 x W: 217 x H: 200 mm

W2 L: 297 x W: 297 x H: 240 mm

W3 L: 362 x W: 362 x H: 290 mm

W4 L: 510 x W: 510 x H: 365 mm

#### Weight packaging (Lamp + package = total)

W1 Total: 0,48 kg

W2 Total: 1,04 kg

W3 Total: 1,46 kg

W4 Total: 3,44 kg

### Measurements

#### W1

Shade height: 125 mm

Shade diameter: 180 mm

Cord length: 3000 mm

#### W2

Shade height: 190 mm

Shade diameter: 280 mm

Cord length: 3000 mm

#### W3

Shade height: 240 mm

Shade diameter: 350 mm

Cord length: 3000 mm

#### W4

Shade height: 305 mm

Shade diameter: 500 mm

Cord length: 3000 mm

## DIFFUSER

WORKSHOP LAMP W2 - W5

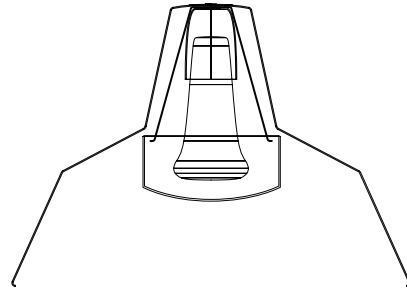

Example with the W2 lamp

The bracket and the semi translucent diffuser fits the socket and the bulb, without any changes to the exterior.

The bracket is made of powder coated aluminium and fits around the supplied socket. It is naturally springy and will hold the diffuser without any use of tools or screws, making the bulb easy to change.

The diffuser is designed to minimize collection of dust, but leaves enough room for the air to flow. It creates a nice even light spread on all kinds of surfaces, and guarantees there is no glare from the lightbulb.

Delivered mounted.

### Material

Polycarbonat  
LT 50%

### Measurements

#### W2 and W3

Diffuser height: 63 mm  
Diffuser diameter: 135 mm

#### W4

Diffuser: 77 mm  
Diffuser diameter: 195 mm

#### W5

Diffuser height: 102 mm  
Diffuser diameter: 270 mm

# MADE BY HAND

---

## GET IN TOUCH

MADE by HAND ApS  
Tømmergravsgade 4B  
2450 Copenhagen SV  
Denmark

info@madebyhand.dk  
+45 70 20 84 64

## LATEST NEWS

More at  
[www.madebyhand.dk](http://www.madebyhand.dk)

